

Shape from Shading on Textured Cylindrical Surface – Restoring Distorted Scanner Images of Unfolded Book Surfaces –

Toshikazu WADA Takashi MATSUYAMA
Department of Information Technology Faculty of Engineering
Okayama University
3-1-1 Tsushima Naka, Okayama-SHI, Okayama, JAPAN

Abstract

In this paper, we present a method to obtain the 3D shape of an unfolded curved book surface from an image taken by an image-scanner. The estimated shape can be used for the restoration of the distorted book image. This problem is a practical application of the shape from shading theory. We confirmed that the estimated shape mostly matches the real shape and the image restoration fairly improves the readability of the book.

1 Introduction

Shape from shading [1] is the problem to reconstruct the 3D shape of an object surface from photometric information, which is one of the fundamental theories in Computer Vision. When the object surface is Lambertian, this problem can simply be formalized by the following equation:

$$I = \rho I_s \cos \theta, \quad (1)$$

where I denotes the image intensity, ρ the albedo of the object surface, I_s the illuminant intensity and θ the angle between the surface normal and the illuminant direction.

The problem to reconstruct the 3D shape from the image intensity can be decomposed into two subproblems:

- Photometric problem: obtain the angle θ from I
- Geometric problem: determine the surface normal from θ

Most of the cases, ρ and I_s are not given a priori. Then the photometric subproblem includes the estimation of the lighting geometry and the albedo function, unless adopting the strong assumptions of uniform illuminant and uniform albedo. These estimation problems are underconstrained and can not be solved for general surfaces and conditions.

As for the geometric subproblem, to determine the surface normal from the angle θ , some constraints are also necessary. Photometric stereo [2] is a method to add constraints, and the shape constraints such as smoothness [3], polyhedral surface [4] [5] and cylindrical surface [6] can be used for this problem.

As described above, the focal point of the shape from shading is to find valid constraints which fill up the incompleteness of the general problem. This is equivalent to find a specific problem which can be solved based on the shape from shading theory.

In this paper, we try to solve the problem to estimate the 3D shape of an unfolded book surface from an image taken by an image-scanner.

The image-scanner takes a sequence of 1-dimensional images by a movable linear CCD sensor, and combines them to a 2-dimensional image. The object surface is illuminated

by a linear light source. We assume that the center line separating book pages is located parallel to the CCD sensor.

The constraints which are valid for this problem are:

- Book shape is cylindrical.
This means that the surface normal can be directly determined from θ .
- Albedo function is binary (black/white).
Under this constraint, the image intensity I at the constant albedo region can be extracted by finding the brightest pixels in each scan line. The constant albedo region means the white background of the book surface.

These constraints simplify this problem. But these are not enough to solve it, because the illuminant intensity I_s is not derived from these constraints.

Then we assume:

- Lighting geometry is given.
By this assumption, the illuminant intensity I_s on the object surface can be obtained a priori. But the illuminant intensity of the image-scanner varies with the gap d between the scanning plane and the object surface. We will denote it by function $I_s(d)$.

While the knowledge about the lighting geometry simplifies the problem, the variable illuminant intensity $I_s(d)$ introduces a new complication. That is, if the gap d is obtained, θ can be calculated by equation 1 and the surface normal can be obtained. But the gap d essentially should be computed from the surface normal vectors.

In this paper, we will describe three types of methods to estimate θ and d , and discuss their properties.

Images of unfolded book surfaces taken by a scanner include photometric and geometric distortions because of the gap between the flat scanning plane and the book surface. When we reconstruct the 3D shape of the book surface, these distortions can be restored based on the reconstructed shape.

In section 2, some definitions are given, and a reconstruction method is described in section 3. Some experimental result are shown in section 4. Section 5 is the conclusion.

2 Image-Scanner and Book Surface

In this section, we investigate properties of the image-scanner and the book surface.

2.1 Image-scanner

The apparatus we use to take images is an image-scanner. This scanner has a flat scanning plane, a linear light source L , a linear mirror M , a lens C and a linear CCD sensor D

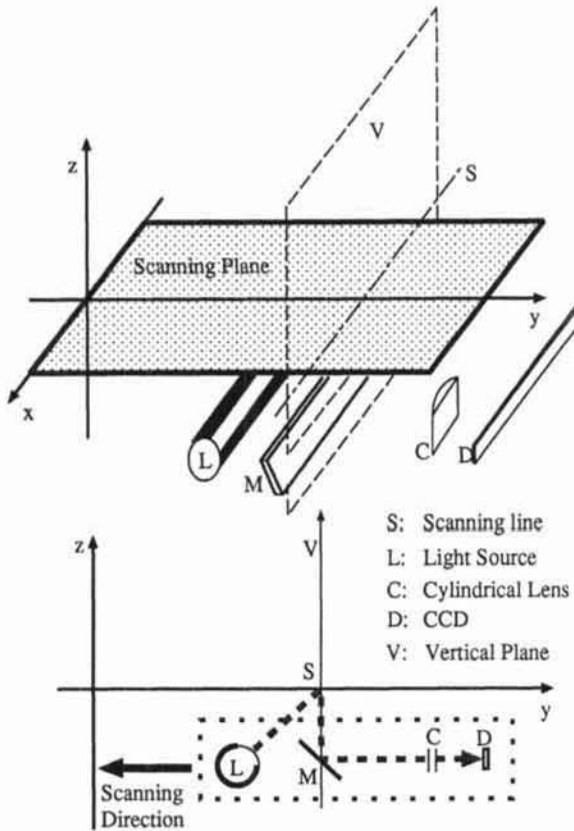

Figure 1: Structure of the image-scanner.

as shown in Figure 1. The linear sensor D , mirror M and the light source L are aligned to be parallel to each other.

Here we introduce the orthogonal coordinate system as shown in Figure 1: the y -axis parallel to the scanning direction, the x -axis parallel to the linear sensor, and the z -axis orthogonal to the scanning plane. The x -axis and y -axis are included in the scanning plane.

The mirror M guides the reflected light to the sensor D . The crossing line between the x - y plane and the vertical plane V is called a scanning line S . The light source L and the mirror M move under the x - y plane, the lens C and the sensor D follow keeping the constant distance.

The sensor C takes a 1-dimensional image $I(x)$ for each scanning line. The 2-dimensional image $I(x, y)$ is obtained by combining the sequence of $I(x)$ s. While each 1-dimensional image is obtained by the central projection, the projection along the scanning direction is equivalent to the orthogonal projection.

The light source L is not located on the vertical plane V , and the radiance is not uniformly distributed. Then, the illuminant intensity on the object surface $I_s(d)$ varies with the distance $d(y)$ between the object and the scanning plane.

2.2 Book Surface

Here we assume that the unfolded book surface is located on the scanning plane so that the center line separating book pages is just above the x -axis as shown in Figure 2.

While tracking along the y -axis, the book surface touches the scanning plane at y_0 as shown in Figure 2. Then the

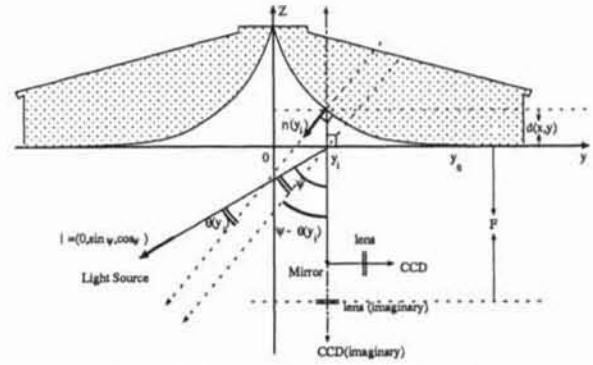

Figure 2: Geometry of the book surface.

following conditions hold in the region $y \geq y_0$:

$$d(y)|_{y>y_0} = 0, \quad \frac{d d(y)}{dy} \Big|_{y>y_0} = 0, \quad \theta(y)|_{y>y_0} = \psi, \quad (2)$$

where ψ represents the light source direction as shown in Figure 2.

The gap $d(y)$ can be represented as:

$$d(y) = \int_y^{y_0} \tan(\psi - \theta(\zeta)) d\zeta. \quad (3)$$

3 Shape Reconstruction

From equations 1 and 3, we have:

$$I_w(y) = \rho_w I_s \left(\int_y^{y_0} \tan(\psi - \theta(\zeta)) d\zeta \right) \cos \theta(y), \quad (4)$$

where $I_w(y)$ and ρ_w represent the intensity and the albedo at the white background respectively, and can be calculated by:

$$I_w(y) = \max_x I(x, y), \quad \rho_w = I_w(y)|_{y \geq y_0} / I_s(0). \quad (5)$$

The digital version of equation 4 is:

$$I_w(y_i) = \rho_w I_s \left(\sum_{k=0}^i \tan(\psi - \theta(y_k)) \right) \cos \theta(y_i), \quad (6)$$

where $y_0 > y_1 > \dots > y_i$.

There are 3 types of methods to calculate θ_i based on equation 6:

method 1 Assuming that $\tan(\psi - \theta(y_i))$ can be neglected, we can calculate $\theta(y_i)$ sequentially by the following equation:

$$\theta(y_i) \simeq \cos^{-1} \left(\frac{I_w(y_i)}{\rho_w I_s \left(\sum_{k=0}^{i-1} \tan(\psi - \theta(y_k)) \right)} \right). \quad (7)$$

method 2 More precisely, we can calculate $\theta(y_i)$ sequentially by minimizing the function $G(\theta(y_i))$ defined by:

$$G(\theta(y_i)) = \left\{ I_w(y_i) - \rho_w I_s \left(\sum_{k=0}^i \tan(\psi - \theta(y_k)) \right) \cos \theta(y_i) \right\}^2. \quad (8)$$

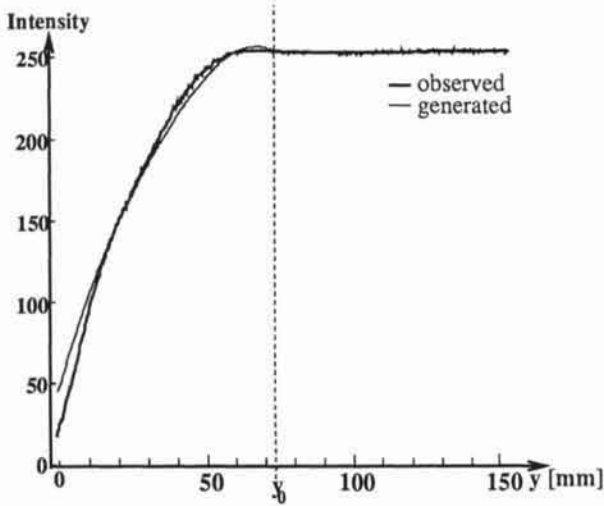

Figure 3: Observed intensity and generated intensity.

method 3 The most precise method is to find the sequence of θ s simultaneously which minimize the functional H :

$$H(\theta(y_0), \theta(y_1), \dots, \theta(y_n)) = \sum_{k=0}^n G(\theta(y_k)). \quad (9)$$

The method 1 and 2 can be realized by an incremental calculation. In these methods, the calculation at y_i depends the preceding results at y_0, y_1, \dots, y_{i-1} , and the numerical error grows up while proceeding the calculation. Especially, method 1 can not be applied when the argument of the \cos^{-1} exceeds $[-1, 1]$. As for the method 3, we can use a multi-dimensional non-linear optimization algorithm. To use it, however the initial estimate of $\theta(y_i)$ must be given and the algorithm is computationally expensive for big data.

Considering these characteristics of the three methods, we designed the following procedure to reconstruct the 3D book shape:

1. Calculate the image intensity $I_w(y)$ and the albedo ρ_w at the constant albedo region by equation 5.
2. First, calculate each $\theta(y_i)$ incrementally by method 2, then correct such part of θ s by method 3 where the error $G(\theta)$ becomes large. Estimated θ s by method 2 are used as the initial estimate for method 3.

4 Experiments

For experiments, we prepare an object with a known cylindrical surface and print an undistorted book image on its surface. The object is located on the image-scanner so that the axis of the cylindrical surface be aligned to the x -axis. The image-scanner is placed in a dark box to shut out the external light.

Figure 3 represents the intensity $I_w(y)$ of the white background ($0 \leq y \leq y_{\max}$). The bold line denotes the observed intensity and the thin line the intensity generated by equation 6 using the real 3D shape. In this figure, the observed intensity pattern mostly matches the generated one. But the error grows up near around $y = 0$.

In the narrow region $y_0 - \Delta y < y < y_0$, the generated intensity slightly exceeds the intensity at $y > y_0$. This property of the image intensity pattern is sometimes undetectable

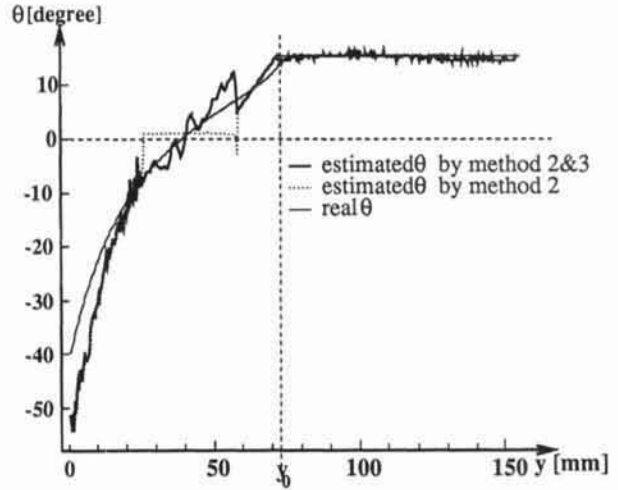

Figure 4: Estimated $\theta(y)$ and real $\theta(y)$.

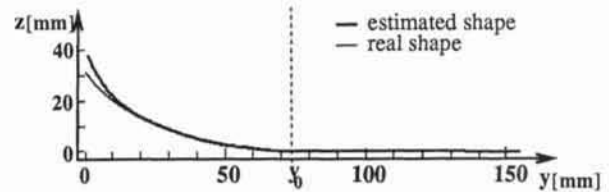

Figure 5: Estimated shape and real shape.

when the gradient of the object surface is too small at y_0 as in this example. If this property can not be detected from the observed intensity pattern, we would obtain θ s which are greater than ψ at $y < y_0$ by method 2. Such θ s lead to a nonexisting shape with negative gap ($d(y) < 0$). To avoid this problem, we used the following model matching procedure:

First, we calculate average intensity \bar{I}_w in the constant intensity region $[y_0^*, y_{\max}]$, where the following equation holds in the interval for a small constant ϵ :

$$\forall y \in [y_0^*, y_{\max}], \quad \bar{I}_w - \epsilon \leq I_w(y) \leq \bar{I}_w + \epsilon. \quad (10)$$

Find a point $y_{0\Delta}$ satisfying the following equation for a small constant ΔI :

$$I_w(y_{0\Delta}) = \bar{I}_w - \Delta I. \quad (11)$$

We assume the following model of θ in the interval $[y_{0\Delta}, y_{\max}]$:

$$\theta(y_i) = \begin{cases} \psi & y_i \geq y_0 \\ \alpha(y_0 - y_i) + \psi & y_{0\Delta} \leq y_i < y_0 \end{cases}, \quad (12)$$

and determine α and y_0 which minimize the error function G . This assumption means that the book shape around y_0 is the circular cylinder. In the interval $[0, y_{0\Delta}]$, $\theta(y_i)$ can be calculated by method 2 and method 3.

The θ s estimated from the observed intensity is illustrated in Figure 4. The bold line denotes the estimated result and the thin line the real θ s. When the surface normal is close to the lighting direction, that is, the parameter θ is almost zero, the error of the estimation by method 2 becomes considerably large. Such errors are corrected by method 3. This poor estimation may be caused by:

- the error of the model matching around y_0 .
- the error function G becomes rather flat around $\theta = 0$.

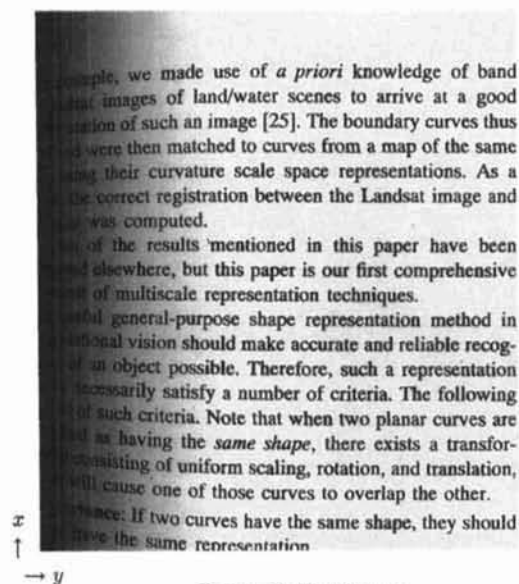

Figure 6: Test image.

Figure 5 represents the estimated shape of the book surface. The bold line denotes the estimated shape and the thin line the real shape. The estimated shape almost matches the real shape. But the estimated shape becomes deeper than the real one while decreasing y . This is because the observed intensity is darker than the generated one near around $y = 0$ as shown in Figure 3.

Figure 6 and 7 show the image taken by the scanner and its restored version respectively. The geometric and photometric distortions were recovered by following methods:

- geometric distortion along the y -axis caused by the gradient of the book surface.

The shrinking ratio along the y -axis is $\cos(\psi - \theta(y_i))$. Hence, the geometric restoration can be done by stretching a pixel to $1/\cos(\psi - \theta(y_i))$ pixels.

- geometric distortion along the x -axis caused by the central projection.

A 3D point $(x_0, y_i, d(y_i))$ is projected on to the point $(x_d(x_0, y_i), y_i)$ in the x - y plane by the central projection. The function x_d is defined by the following equation:

$$x_d(x, y_j) = \frac{Fx}{F + d(y_j)} \quad (13)$$

where F represents the distance between the principal point of the lens and the scanning plane (see Figure 2). The restoration is to simulate the orthogonal projection by moving the projected point $(x_d(x_0, y_i), y_i)$ to (x_0, y_i) . This restoration can be done by the inverse function of x_d .

- shading caused by $I_s(d)$ and $\cos(\psi - \theta)$. This distortion can be restored by calculating the albedo distribution based on the calculated 3D shape and using it as the restored image intensity.

We can confirm that the restored image gives us fairly good readability.

5 Conclusions

In this paper, we proposed a method to reconstruct the 3D shape of an unfolded book surface from an image taken by

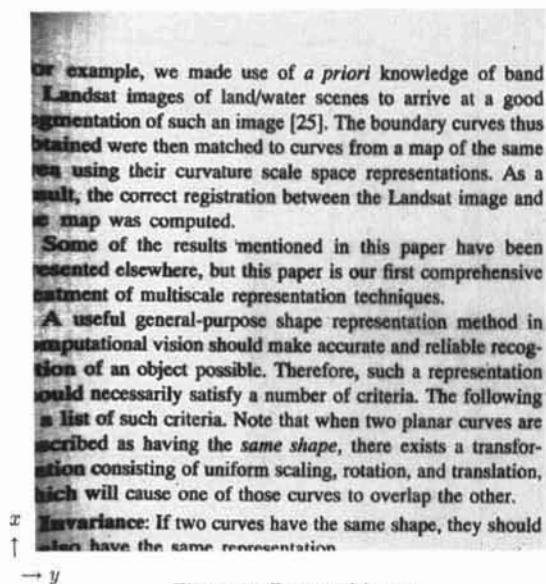

Figure 7: Restored image.

an image-scanner. This problem is considered as a practical application of the shape from shading theory. The calculated 3D shape can be utilized for image restoration. The proposed method is promising while leaving some unsolved problems. Future works for the improvement of the shape estimation include:

- Suitable optical model for this problem.
- Estimation of the point y_0 .
- Intensity model matching around y_0 .
- Stable estimation of $\theta(y)$ around $\theta = 0$.

Acknowledgments

Authors gratefully appreciate Mr. UKIDA's programming support for 3D shape reconstruction and image restoration.

References

- [1] Horn, B. K. P., "Obtaining shape from shading information", *The Psychology of Computer Vision*, P. H. Winston, ed., McGraw-Hill Book Co., New York, pp.115-155, 1975.
- [2] Woodham, R.J., "Photometric method for determining surface orientation from multiple image", *Optical Engineering*, 19,1, 1977.
- [3] Ikeuchi, K., "Determining 3D shape from 2D shading information based on reflectance map technique", *Trans. IECE Japan*, vol.J 65-D, pp.842-849, 1982.
- [4] Mackworth, A., "Interpreting pictures of polyhedral scenes", *Artificial Intelligence*, vol.4, pp.121-137, 1977.
- [5] Huffman, D. A., "A duality concept for analysis of polyhedral scene", *Machine Intelligence 7*, F. W. Elcock and D. Michie, eds., Ellis Horwood, Chichester, pp.279-311, 1977.
- [6] Asada, M., "Cylindrical shape from contour and shading without knowledge of lighting conditions or surface albedo", *Proc. of ICCV*, pp.412-416, 1987.

» Unwrapping Lowrank Textures on Generalized Cylindrical Surfaces. » Retrographic sensing for the measurement of surface texture and shape. » Shape from Contour for the Digitization of Curved Documents. » Least squares conformal maps for automatic texture atlas generation. more ». » Explore Subject Areas Life Sciences Algorithms Applied Computing Artificial Intelligence Augmented Reality Automated Reasoning Bioinformatics Biomedical Imaging Biomedical Simulation Biometrics Business Chemistry Cognitive Science Combinatorics Wada, T., Matsuyama, T.: Shape from shading on textured cylindrical surface restoring distorted scanner images of unfolded book surfaces. In: Proceedings of the IAPR Workshop on Machine Vision and Applications, pp. 591–594. Tokyo, Japan (1992)Google Scholar. 2. Kanungo, T., Haralick, R.M., Phillips, I.: Global and local document degradation models. In: Proceedings of the 2nd International Conference on Document Analysis and Recognition, pp. 730–734. Tsukuba, Japan (1993)Google Scholar. 3.